

RILIEVO METRICO	
---	quote progressive
---	quote parziali dirette
---	quote parziali indirette

RILIEVO MATERICO	
	tufo vesuviano
	mattoni pieni (0,26x0,135x0,06)m
	muratura a sacco in pietra vesuviana con rivestimento in tufo vesuviano
	vuoto nella muratura
	completa assenza di intonaco con evidenza di sottostante muratura
	intonaco di calce e pozzolana privo di pigmenti
	intonaco di calce e pozzolana con pigmenti
	fori d'andito
	vegetazione

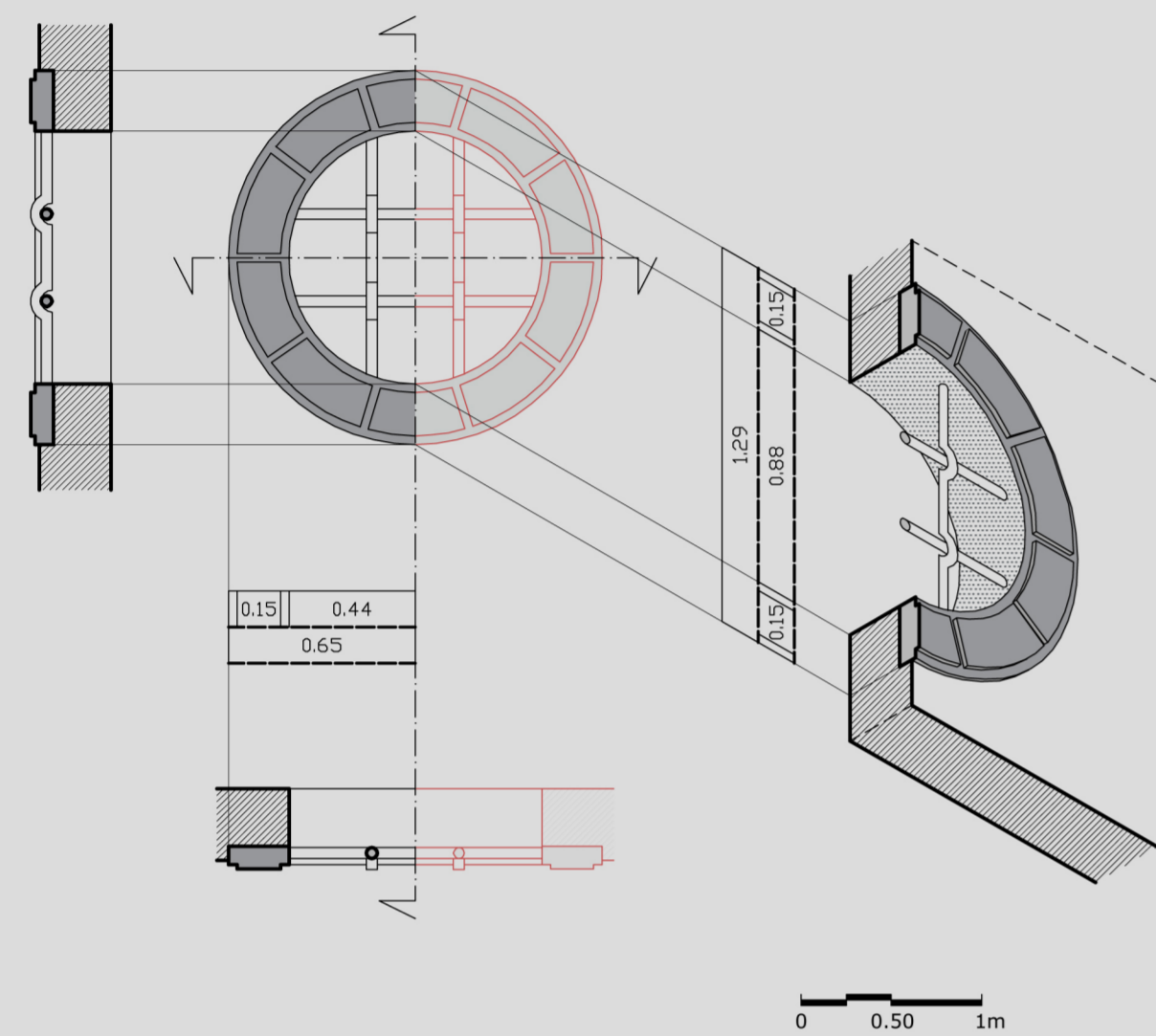

0 0.50 1m

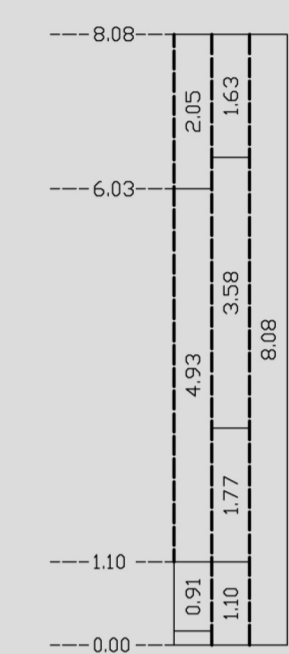
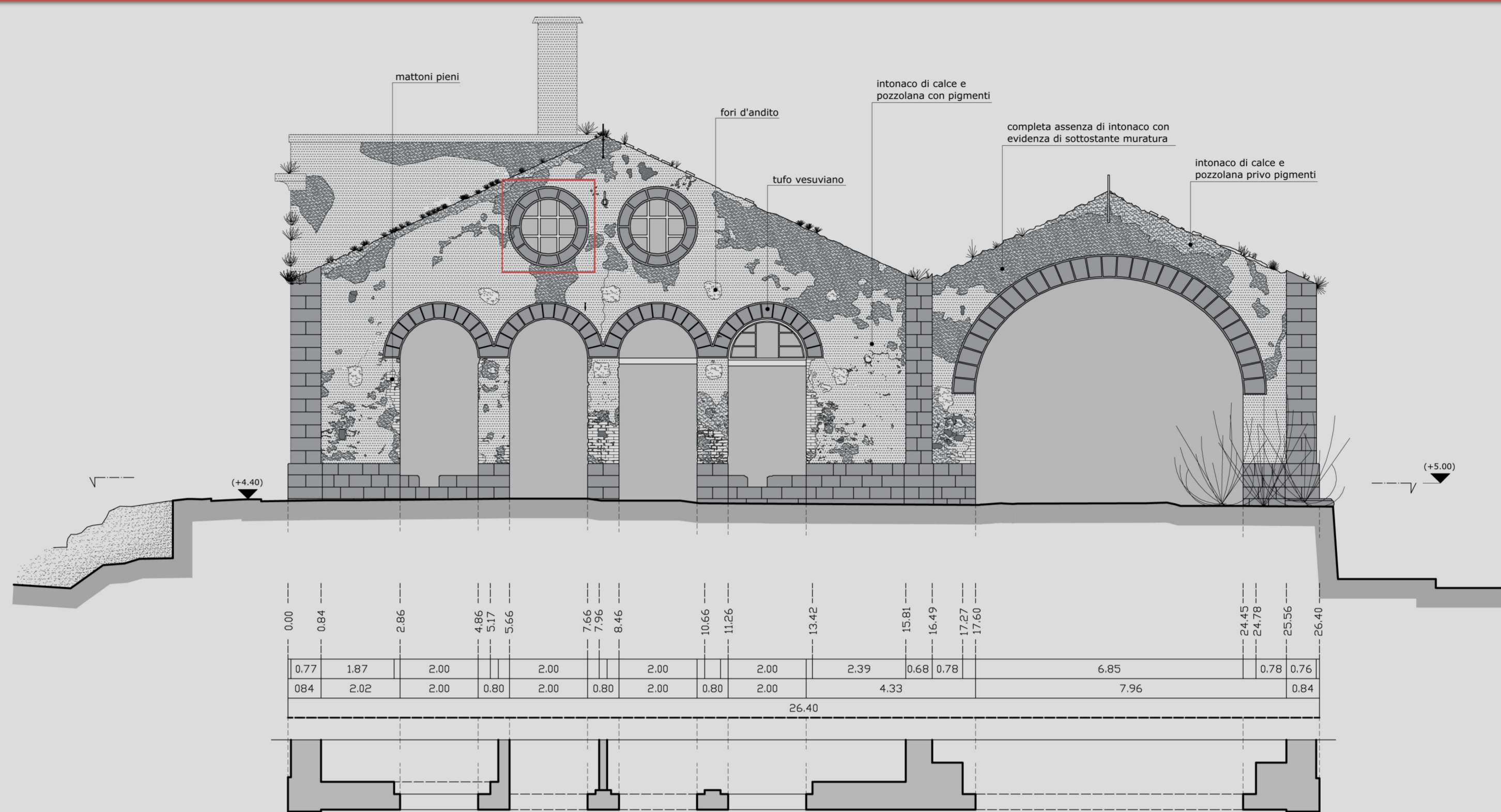
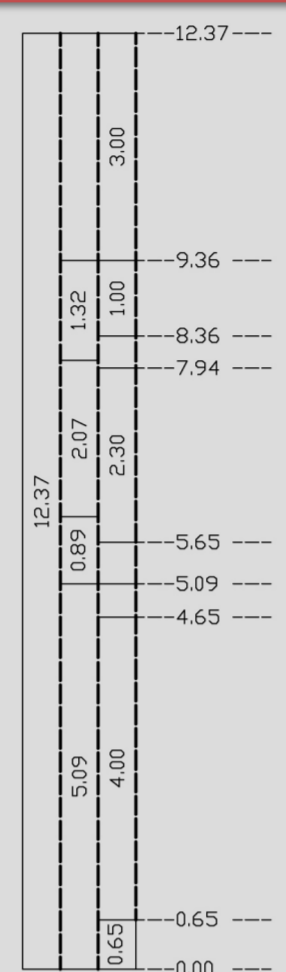

PROSPETTO SUD-EST

PIANTA A QUOTA (+5,00)

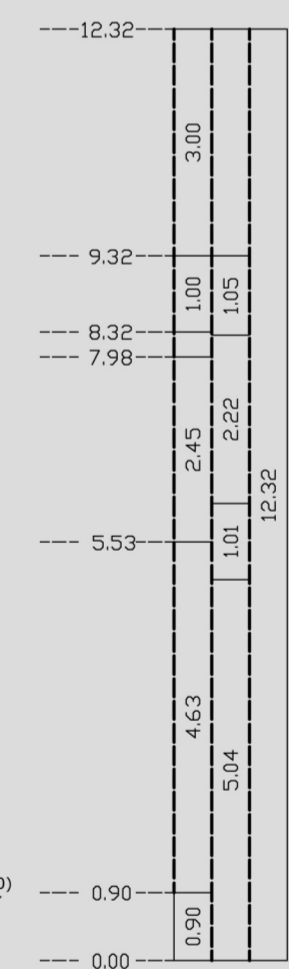
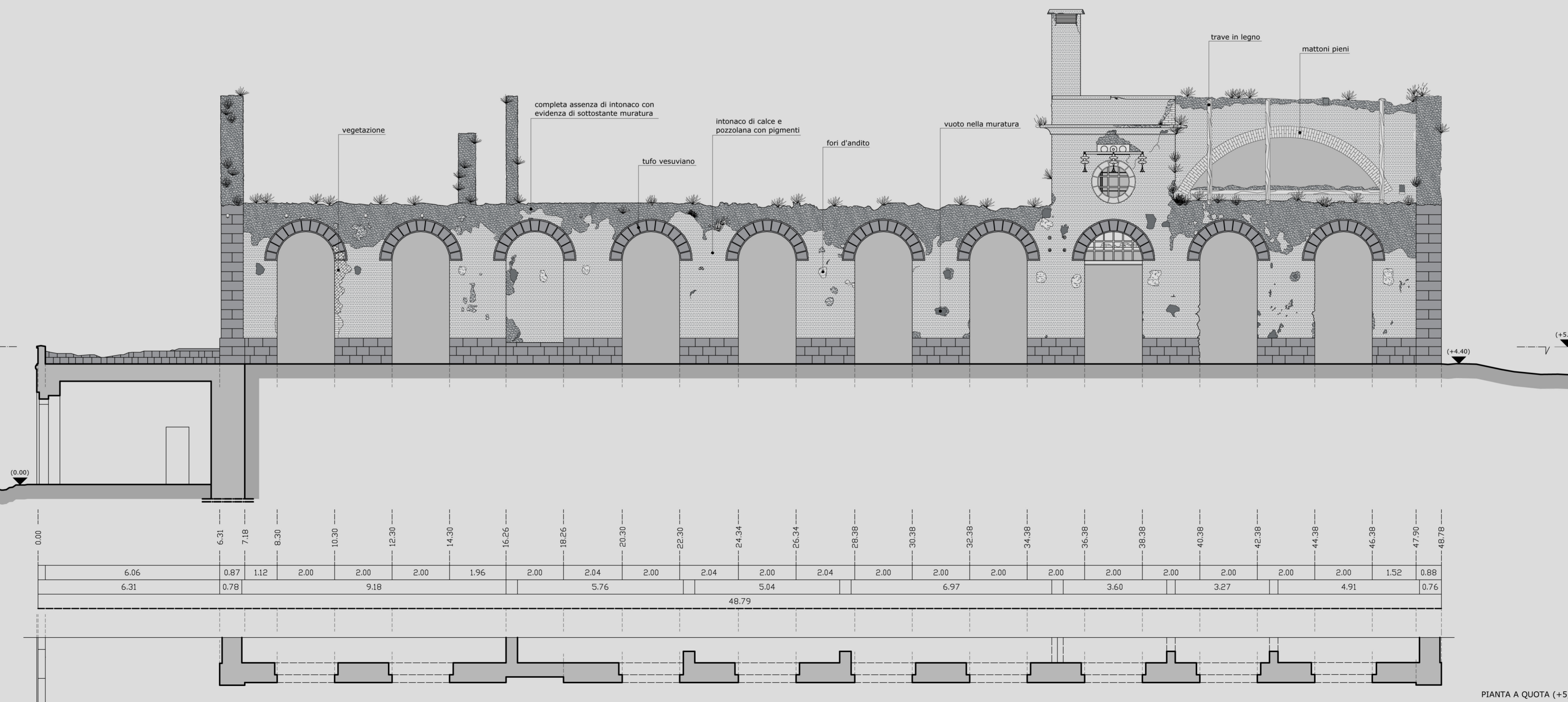
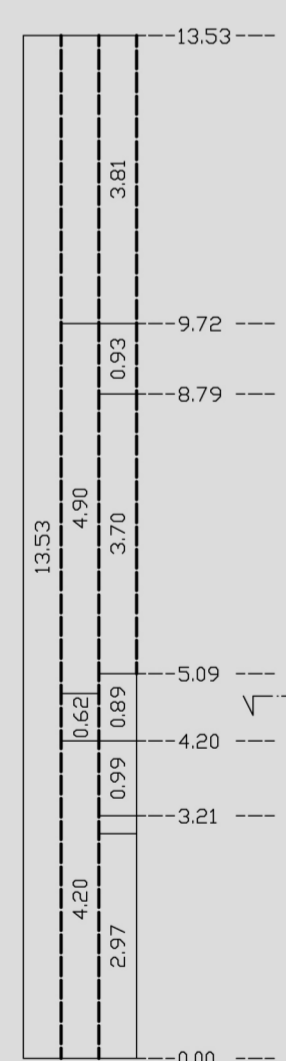

PROSPETTO NORD-EST

PIANTA A QUOTA (+5,00)

0 1 2 3m